

**БЗН 1**

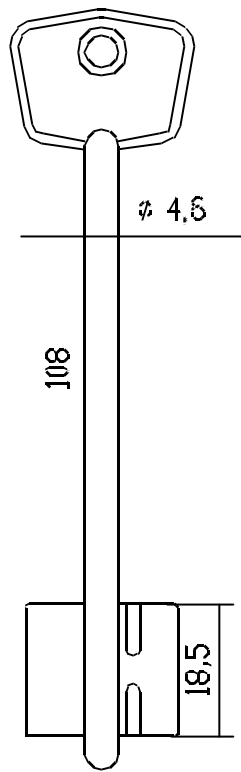

**ГРН 1**

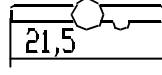
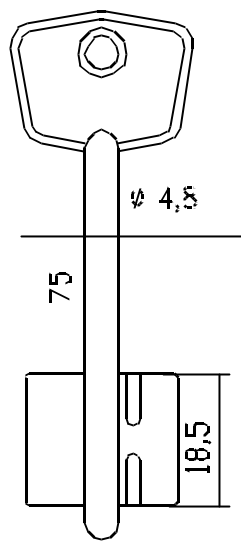

**ГРН 2**

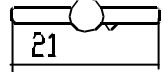
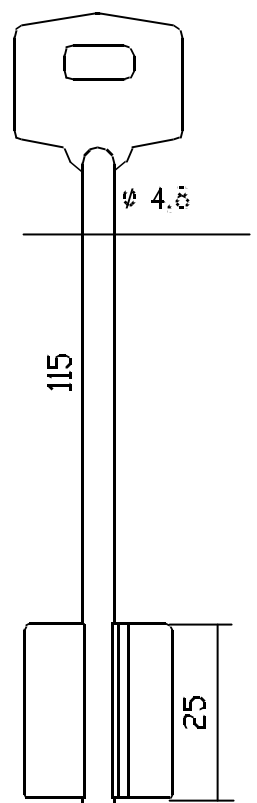

**ГРО 1**

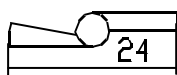
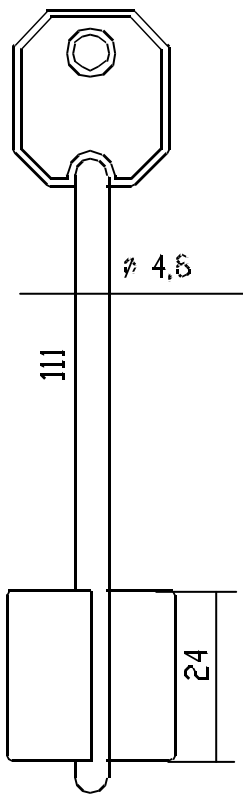

**ДВ 1**

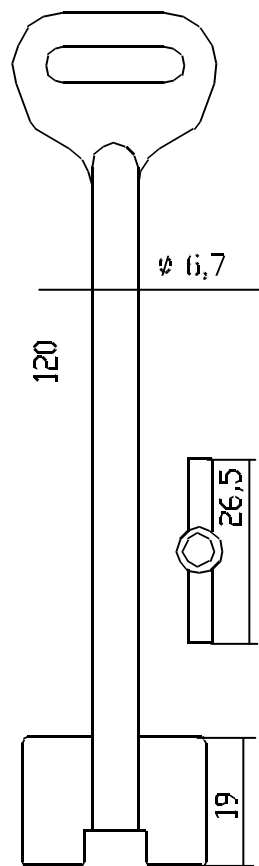

**ДВ 2**

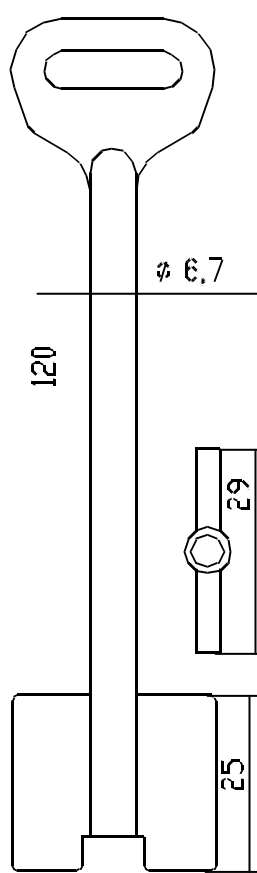

**ДВ 2А**

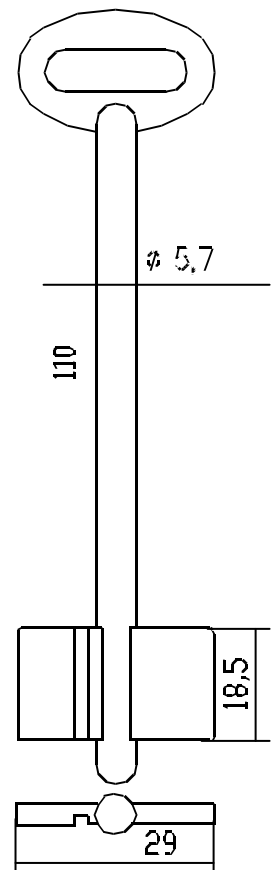

**ДВ 3**

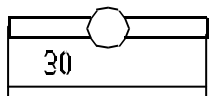
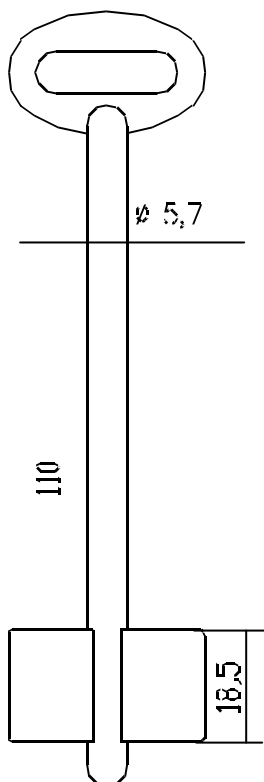

**ДВ 3А**

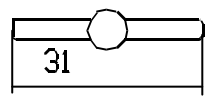
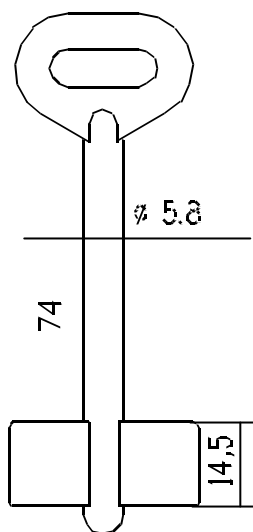

**ДВ 5**

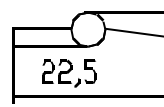
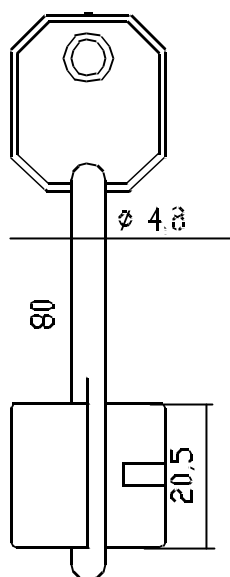

**ДВ 6**

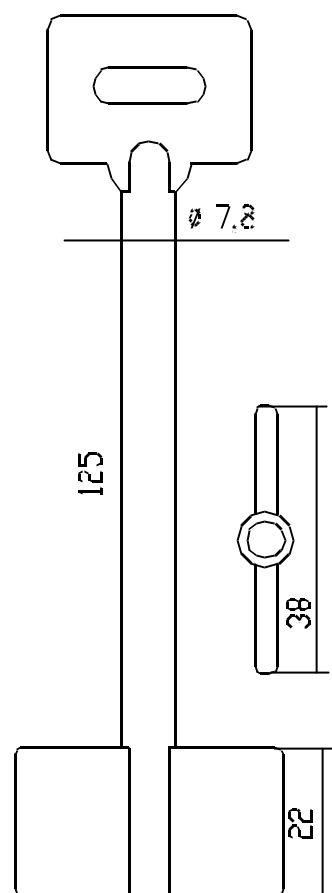

**Д8-2**

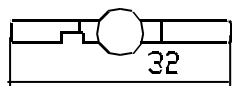
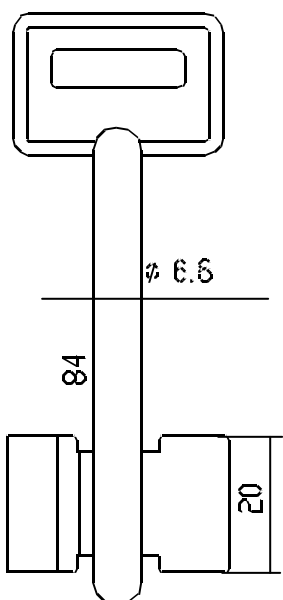

**EPB 1**

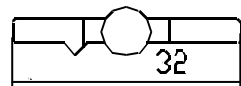
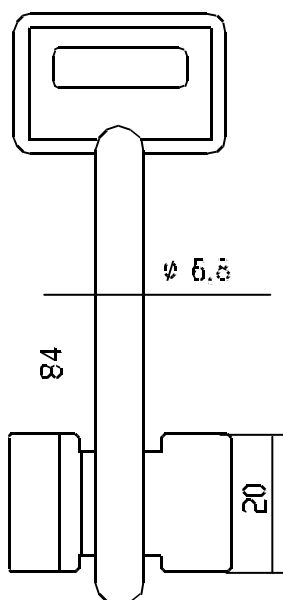

**EPB 2**

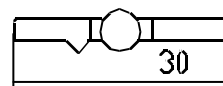
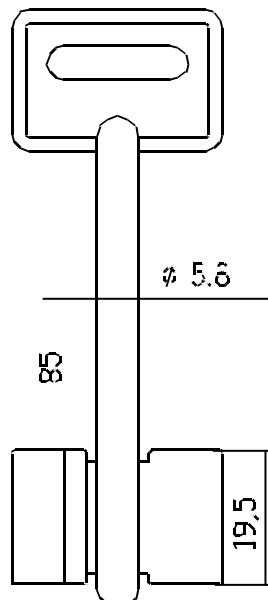

**EPB 4**

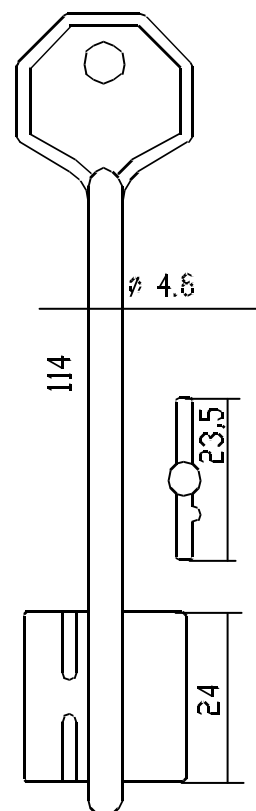

**КПА 1**

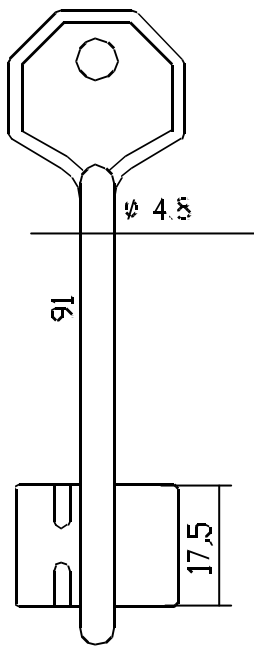

**КЛА 2**

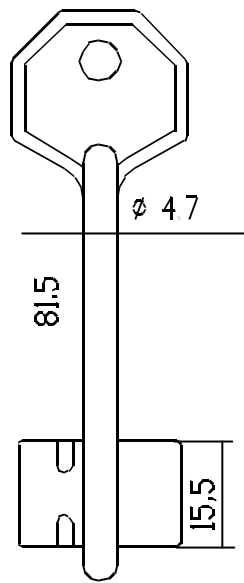

**КЛА 3**

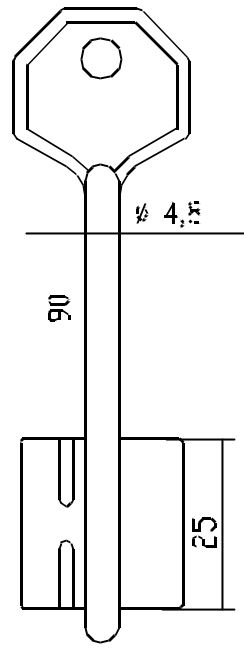

**КЛА 4**

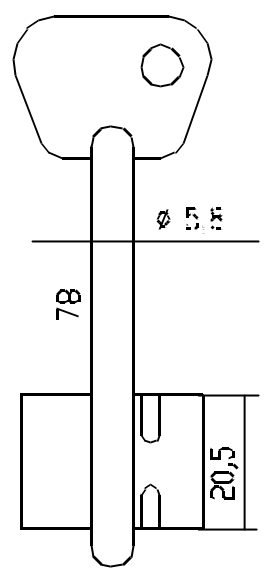

**КРП 1**

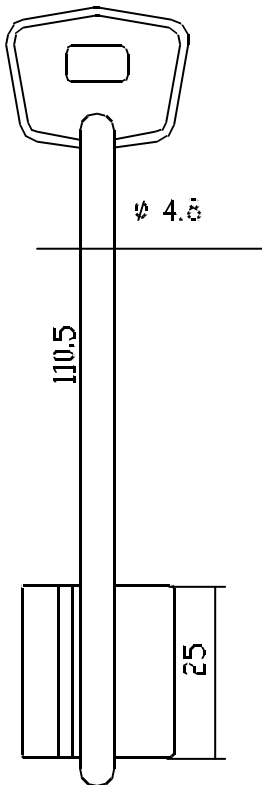

**МТ 1**

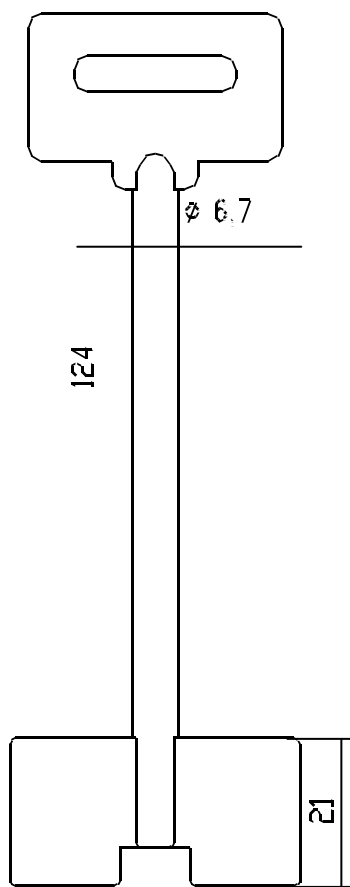

**ПВД 1**

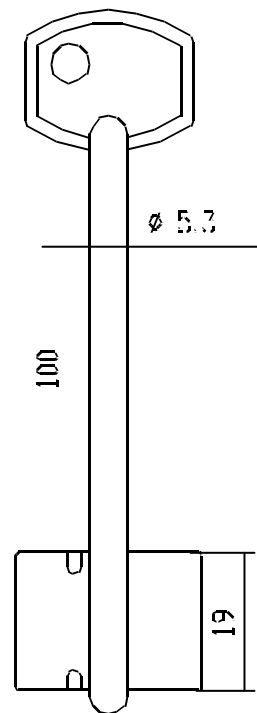

**РГЛ 1**

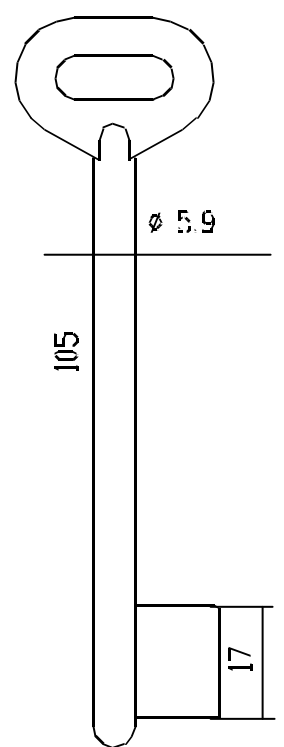

**РУС 1**

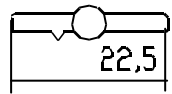
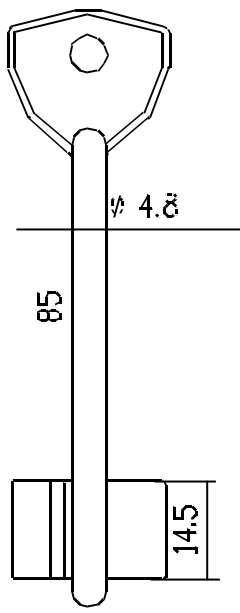

**CAM 2**

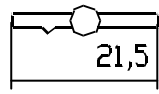
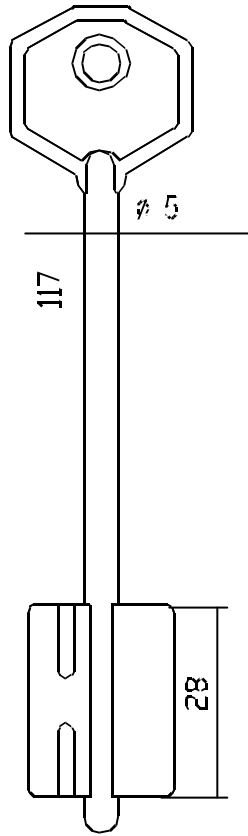

**CHT 1**

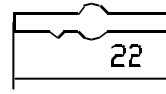
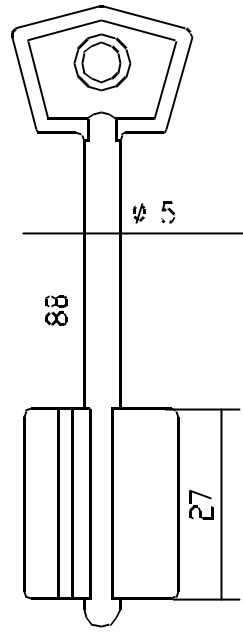

**CHT 2**

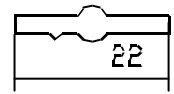
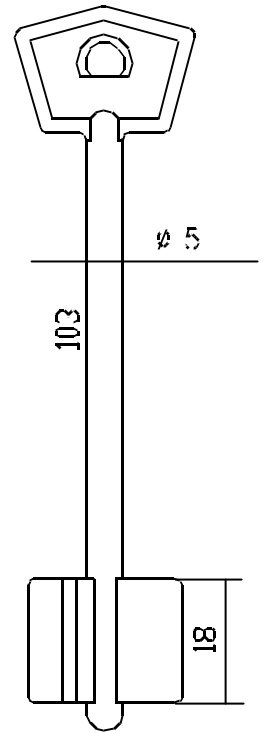

**CHT 3**